

AKWA+FLEX-20

MONO COLOR SPECIFICATION SHEET

Project Name:

Specifier:

Location:

Product Code:

- Material:**
Silicone
- Impact Rating:**
IK08
- Weatherproof Rating:**
IP68
Wet Location
- Operating Temp:**
-40°F - 131°F
- Bending Direction:**
Horizontal
- UL Listed**
- Beam Angle:**
120°
- Dimmable:**
0-10V, DMX
- Bend Diameter:**
>5.90"
- CRI:**
>80+, >90+



	AKWA Silicone Resin Encapsulation Horizontal Bend
Input Voltage	24V
Power Consumption	3.05W/ft
Standard CRI	>80
LEDs per foot/m	37 120
Incremental length in/mm	0.65" 16.6mm

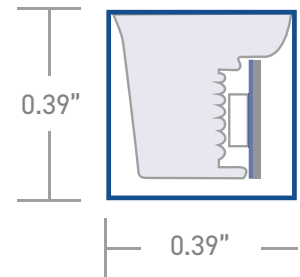

Color Temperature [K]	Lumen Output [lm/ft]
2700K	134lm
3000K	134lm
3500K	140lm
4000K	140lm

Luminaire Options	RGB/W, tunable white & dim to warm available - refer to specific datasheets
Control	0-10V · DMX
Optics	opal symmetrical 120° diffuser
Finish	white
Mounting	surface · wall · recessed
Accessories	mounting channel / profile

Due to tolerances of the production process and the electrical components, values for light output, color temperature and electrical power can vary up to 10%.

How to specify KLIK USA AKWA Flex 20. Example of specification: AF2030K80XX.XBBADIM

Fixture Type	Color Temp [K]	CRI	Nominal Length [feet] with one feed ^{1,2}	Power Entry Location ³	Nominal Power Entry Termination	Mounting Profiles & Brackets	Accessories	Control
AF20	27K 2700K 30K 3000K 35K 3500K 40K 4000K R Red G Green B Blue	80CRI >80+ 90CRI >90+	XX.X Specify run Length [ft]	B Back one end B2 Back each end E End Plate one end E2 End Plate each end SL Side - Left SR Side - Right SLR Side - Left+Right	B Bare cable with anti-wick ferrule [Std] F Female IP68 Connector M Male IP68 Connector	A AF20S01 B AF20S01FLX C AF20S02 D AF20S03 E AF20S04 F AFSSC20S01-100 G AFPC20S01	- Profile [Std] A AF20ADJ	DIM 0-10V Dim [Std] DMX1 DMX 1 Ch

1. Specify length of run

2. Max run length per power entry feed is 16.4' [5m], 32.8' [10m] for 2 x feeds [one at each end]

3. B2, E2 & SLR only required if exceeding the maximum single power entry as indicated above, thus requiring TWO power entries.

AKWA+FLEX-20

POWER ENTRY LOCATIONS



B

Power entry from the BACK of the fixture [one end]

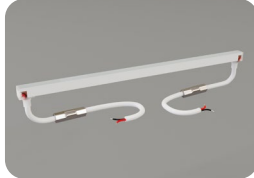

B2

Power entry from the BACK of the fixture [both ends] [for fixture length >16.4']



E

Power entry from the END of the fixture [one end]

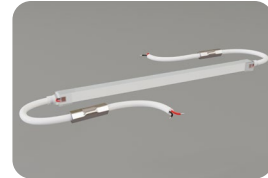

E2

Power entry from the END of the fixture [both ends] [for fixture length >16.4']

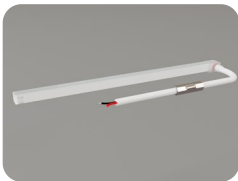

SL

Power entry from the SIDE of the fixture [LHS]



SR

Power entry from the SIDE of the fixture [RHS]



SLR

Power entry from the SIDE of the fixture [both L&R] [for fixture length >16.4']

POWER ENTRY ORIENTATION

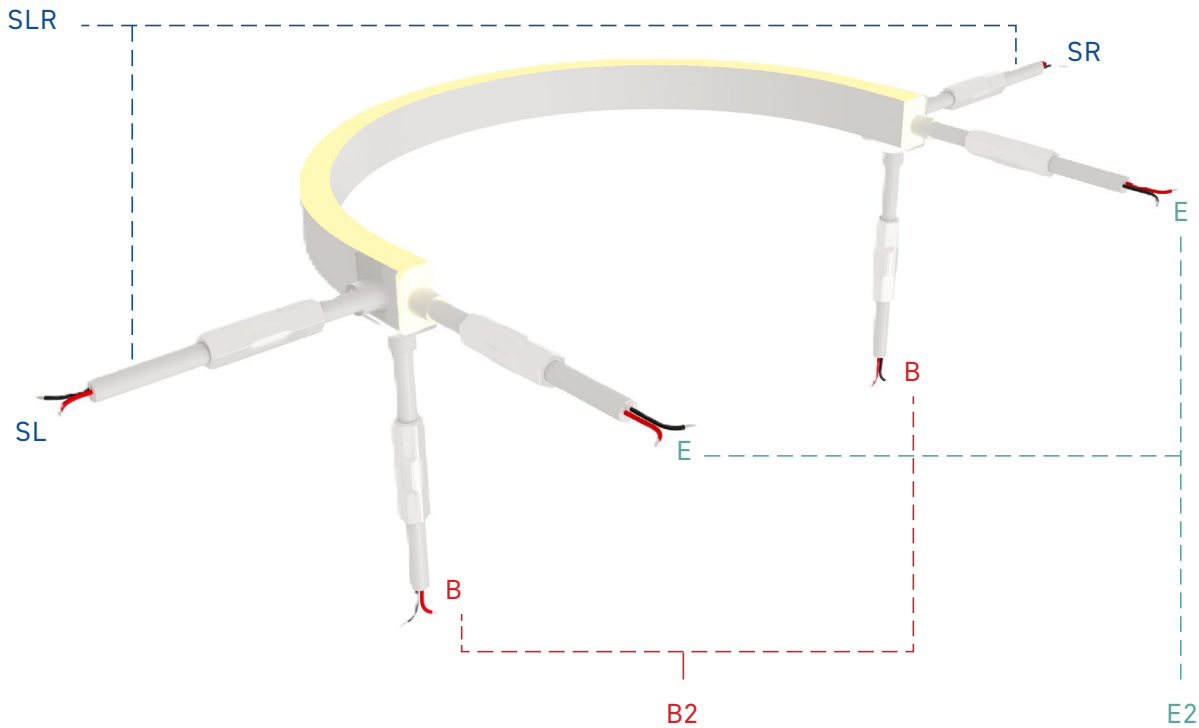

AKWA+FLEX-20 WIRING DIAGRAM

MONO COLOR

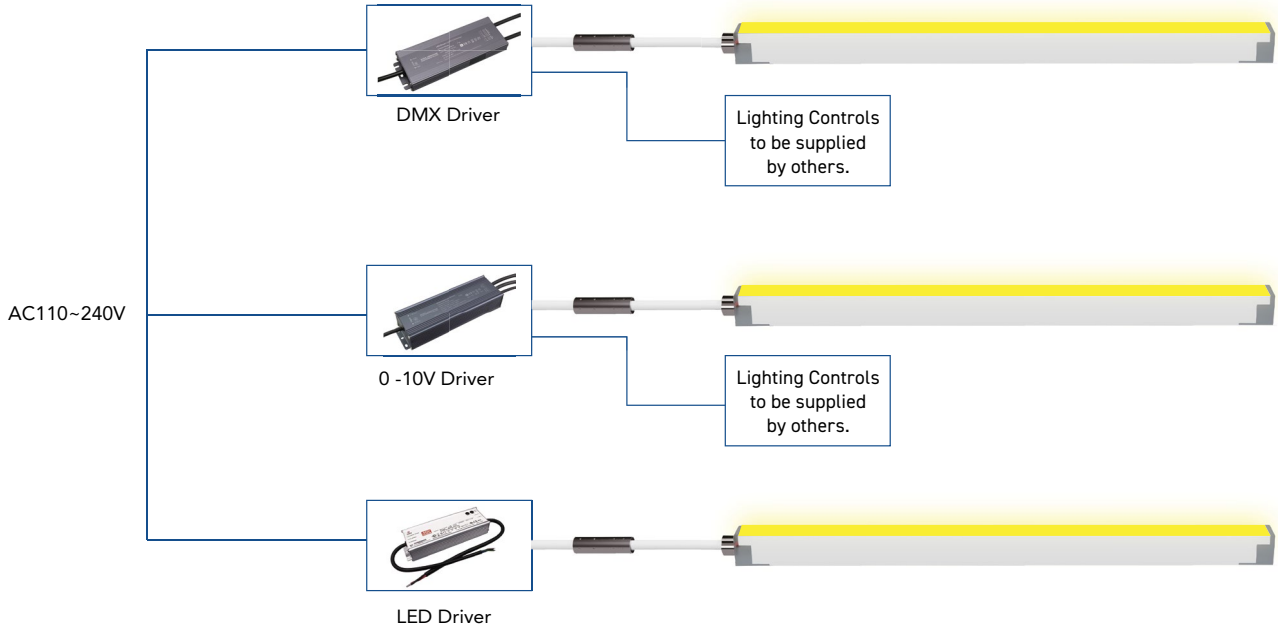

MOUNTING OPTIONS

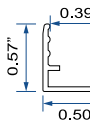
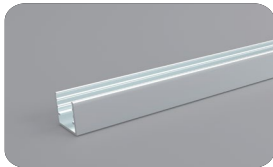

A - AF20S01

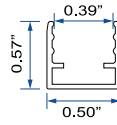
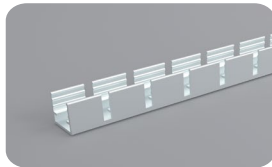

B - AF20S01FLX

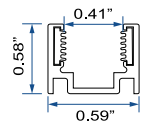

C - AF20S02

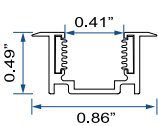

D - AF20S03

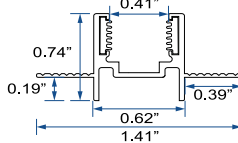
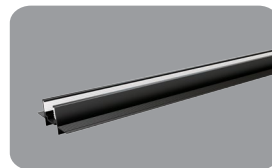

E - AF20S04

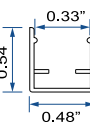

F - AFSSC20S01-100

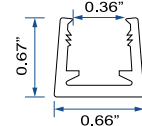

G - AFPC20S01

ACCESSORIES

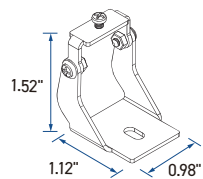

Adjustable Bracket - A - AF20ADJ