

# AKWA+FLEX-70

## RGB/W SPECIFICATION SHEET

Project Name: .....

Specifier: .....

Location: .....

Product Code: .....

- Material:**  
Silicone
- Impact Rating:**  
IK08
- Weatherproof Rating:**  
IP68  
Wet Location
- Operating Temp:**  
-40°F - 131°F
- Bending Direction:**  
Horizontal
- UL Listed**
- Beam Angle:**  
120°
- Dimmable:**  
DMX
- Bend Diameter:**  
>5.90"
- CRI:**  
>80+

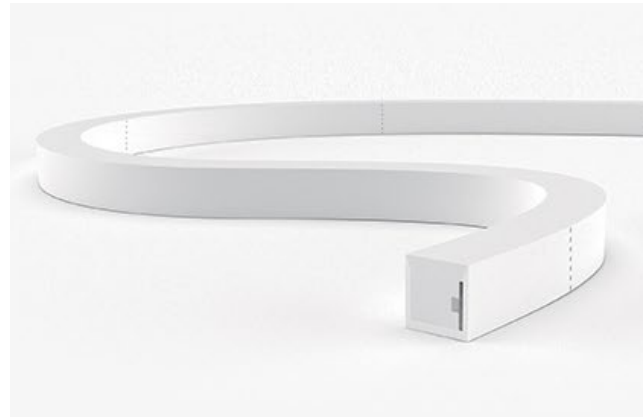

	AKWA Silicone Resin Encapsulation   Horizontal Bend
Input Voltage	24V
Power Consumption	5.2W/ft
Standard CRI	>80
LEDs per foot/m	22   72
Incremental length in/mm	3.28"   83.3mm

Color Temperature [K]	Lumen Output [lm/ft]
Red	7.3lm
Green	29lm
Blue	5.4lm
RGBW	73.4lm
3000K	38lm

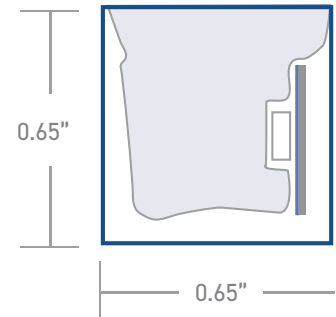

<b>Luminaire Options</b>	Mono & Tunable White available - refer to specific datasheets
Control	DMX
Optics	opal symmetrical 120° diffuser
Finish	white
Mounting	surface · wall
Accessories	mounting channel / profile

Due to tolerances of the production process and the electrical components, values for light output, color temperature and electrical power can vary up to 10%.

How to specify KLIK USA AKWA Flex 70. Example of specification: AF70RGB3XX.XBBADMX4

Fixture Type	Color Temp [K]	Nominal Length [feet] with one feed <sup>1,2</sup>	Power Entry Location <sup>3</sup>	Nominal Power Entry Termination	Mounting Profiles & Brackets	Accessories	Control
AF70	<b>RGB3</b> RGBW[3K] <b>RGB4</b> RGBW[4K]	<b>XX.X</b> Specify run Length [ft]	<b>B</b> Back one end <b>B2</b> Back each end <b>E</b> End Plate one end <b>E2</b> End Plate each end <b>SL</b> Side - Left <b>SR</b> Side - Right <b>SLR</b> Side - Left+Right	<b>B</b> Bare cable with anti-wick ferrule [Std] <b>M</b> Male IP68 Connector <b>F</b> Female IP68 Connector	<b>A</b> AF70S02 <b>B</b> AF70S07 <b>C</b> AF70S08 <b>D</b> AF70H02 <b>E</b> AFPC70S02-T <b>F</b> AFSSC70S01-05 <b>G</b> AFSSC70FLX <b>H</b> AFSSC70S02-100 <b>I</b> AF70S02FLX <b>J</b> AF70S8FLX	- Profile [Std] <b>A</b> AF70ADJ	<b>DMX4</b> DMX RGBW

1. Specify length of run

2. Max run length per power entry feed is 16' [4.9m] and 32' [9.8m] for 2 x feeds [one at each end]

3. B2, E2 & SLR only required if exceeding the maximum single power entry as indicated above, thus requiring TWO power entries.

# AKWA+FLEX-70

## POWER ENTRY LOCATIONS



**B**

Power entry from the BACK of the fixture [one end]



**B2**

Power entry from the BACK of the fixture [both ends] [for fixture length >16']



**E**

Power entry from the END of the fixture [one end]

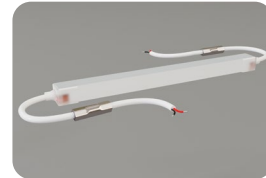

**E2**

Power entry from the END of the fixture [both ends] [for fixture length >16']

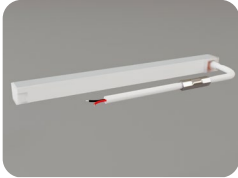

**SL**

Power entry from the SIDE of the fixture [LHS]



**SR**

Power entry from the SIDE of the fixture [RHS]



**SLR**

Power entry from the SIDE of the fixture [both L&R] [for fixture length >16']

## POWER ENTRY ORIENTATION

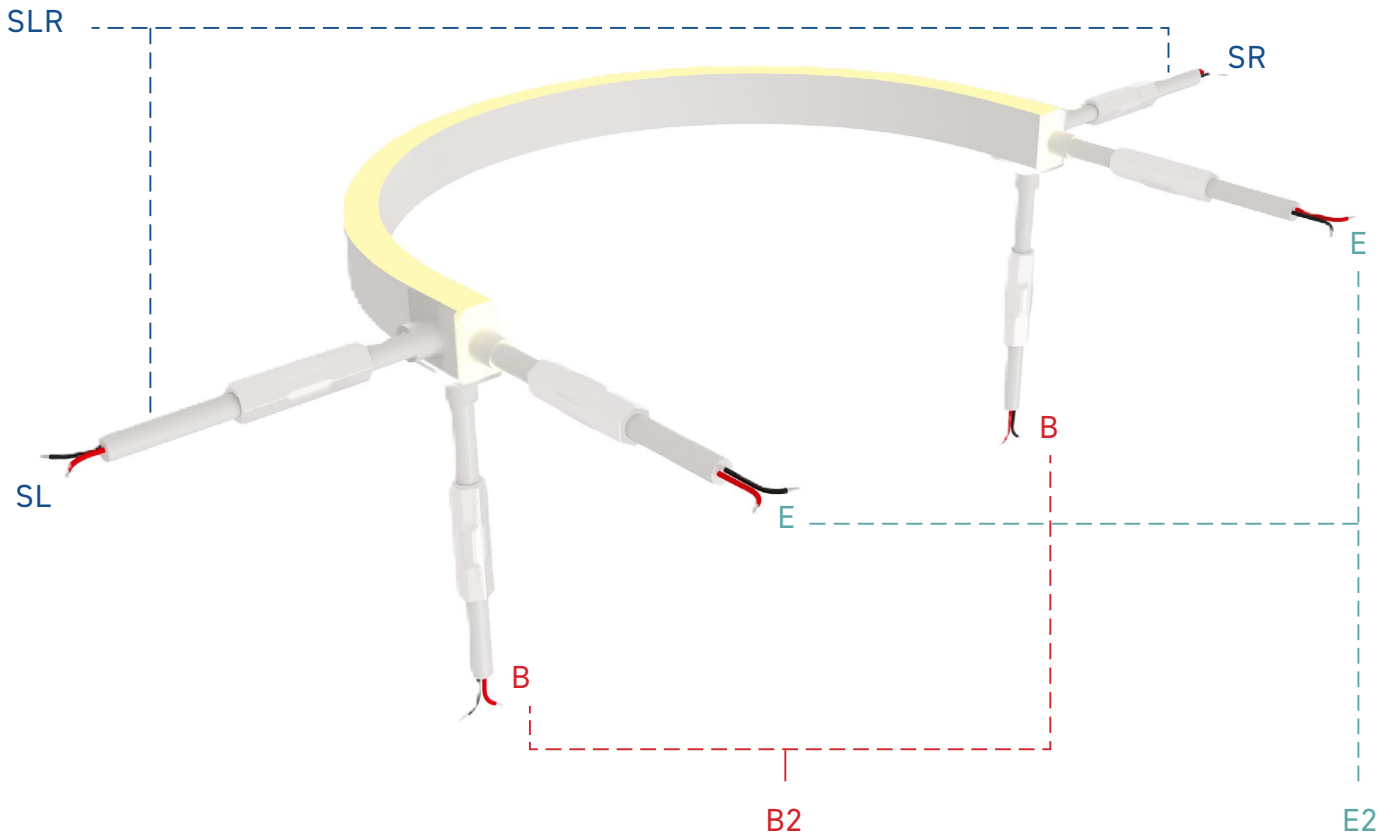

# AKWA+FLEX-70 WIRING DIAGRAMS

## RGBW

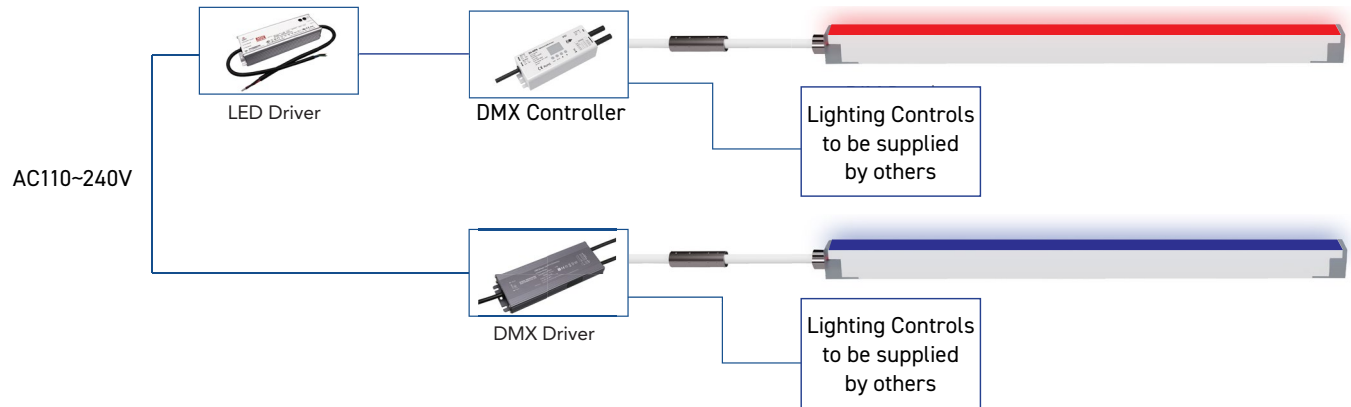

## MOUNTING OPTIONS

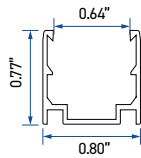

A - AF70S02

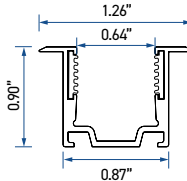

B - AF70S07

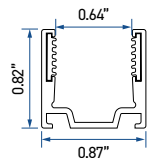
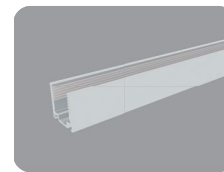

C - AF70S08

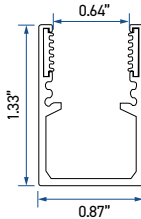
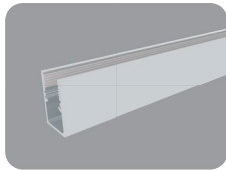

D - AF70H02

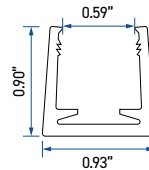
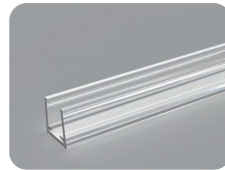

E - AFPC70S02-T

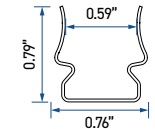
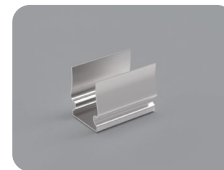

F - AFPSS70S01-05

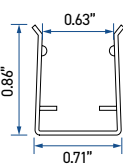
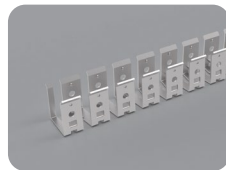

G - AFSSC70FLX

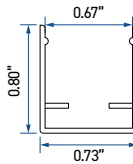

H - AFSSC70S02-100

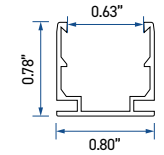
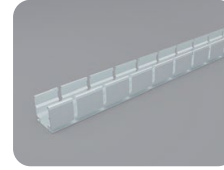

I - AF70S05FLX

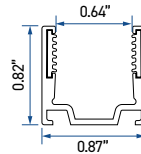
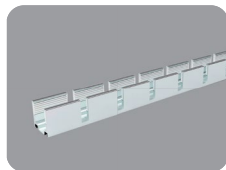

J - AF670S08FLX

## ACCESSORIES

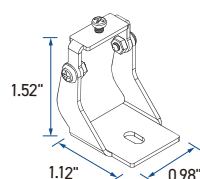

Adjustable Bracket - A - AF70ADJ